

12/19/2011

Halogen Lamps

**Halogen Lamp
75 Watt PAR30 Series**

Project:	
Catalog#:	
Approved by:	

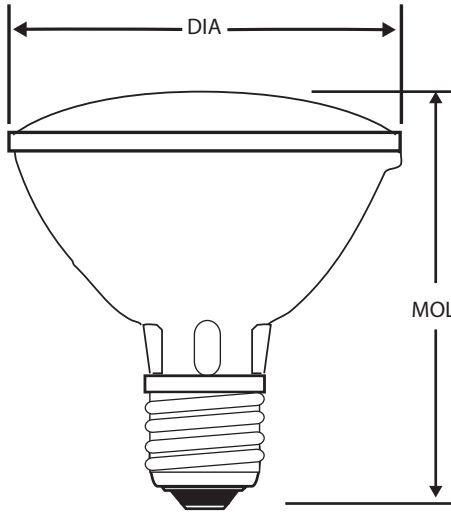

Ordering Information		
Howard Catalog Number (Ordering Code)	75PAR30/H/SP-130	
UPC Code	01314	
Description	PAR30 Halogen	
Package Quantity	30	
Physical Characteristics		
Filament	CC-8	
Base	Med. (E26)	
Beam Spread	Spot	
DIA (Diameter) (in)	3.70	
MOL (Maximum Overall Length) (in)	3.60	
Operating Characteristics		
Beam Angle Degree	12	
Volts	130	120
Watts	75	66
Approx. Lumens Initial (lm)	980	764
Average Rated Life (hours)	2500	5000

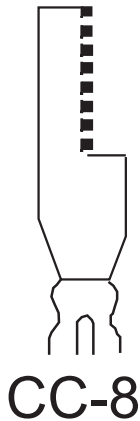

Note:

1. Never disassemble or modify lamp.
2. Specifications subject to change. Actual results may vary.
3. Tungsten halogen lamps operate at high temperatures. Therefore, it is suggested to let the lamp cool completely before replacing.