



Welcome To Howard Technology Solutions!

HOWARD™

Software Development Payee Testing

01:29

Look up your account information using one of the options below.

TEST DATA



SCAN the barcode on your
bill below.

TEST DATA

1 2 3 4 5 6 7 8 9

Touch here to ENTER
account number

< Back

Welcome To Howard Technology Solutions!

HOWARD™

Software Development Payee Testing

01:20

Select a bill to pay by tapping below

Customer Account

12345

HUMAN/I

123 Hickory Dickory Dock Rd.
Sumrall, MS 39482

Pay?	ID	Name	Billing Address	Due Date	Balance
<input type="checkbox"/>	003	HUMAN/I	123 Hickory Dickory Dock Rd.	8/25/2014	\$360.00

 Cancel / Exit

Pay Now 

Welcome To Howard Technology Solutions!



01:25

Cash Payment Disclaimer

Before you pay by cash, please be aware of these conditions

This kiosk does NOT provide change.

This kiosk will NOT return any bills you deposit.

The entire cash amount inserted will be applied to your account, even if your session is interrupted by a power loss or network outage.

To ACCEPT these conditions, touch CONTINUE

OR

Touch BACK to choose another payment method

 Cancel / Exit

 Back

Continue 

Welcome To Howard Technology Solutions!



01:17

Required Information

In order to process your check payment, we are required to ask for the following



First and Last Name

To **ACCEPT** these conditions, touch **CONTINUE**

OR

Touch **BACK** to select another payment method



Cancel / Exit



Back

Continue >

Welcome To Howard Technology Solutions!

HOWARD™

Software Development Payee Testing

01:27

Select Account or Invoice

Account

Invoice



Please enter your account number
using the on-screen keypad

Searching Software Development Payee

 Using TEST Data

tap button for more info



1	2	3
4	5	6
7	8	9
	0	

 Back

Continue 

Welcome To Howard Technology Solutions!

HOWARD™

Software Development Payee Testing

01:23

What amount would you like to pay?

Enter the dollar amount and touch Continue.

\$360.00



1	2	3
4	5	6
7	8	9
	0	

Payment Account

12345-003
HUMAN/I
123 Hickory Dickory Dock Rd.
Sumrall, MS 39482

Total Balance Due

\$360.00

Cancel / Exit

Back

Continue

Welcome To Howard Technology Solutions!

HOWARD™

Software Development Payee Testing

01:21

Please provide and verify all information below

What is your first name?

IMA

		1	2	3	4	5	6	7	8	9	0	-	ⓧ DELETE				
			Q	W	E	R	T	Y	U	I	O	P	'				
			A	S	D	F	G	H	J	K	L	.					
			Z	X	C	V	B	N	M	,							
					SPACE												
ⓧ Cancel / Exit					⏪ Back					Continue ⏩							

Welcome To Howard Technology Solutions!

HOWARD™

Software Development Payee Testing

01:25

Select how you will pay by touching one of the buttons below

Customer Account
12345-003

HUMAN/I
123 Hickory Dickory Dock Rd.
Sumrall, MS 39482



Touch here to pay by
CASH



Touch here to pay by
CREDIT or DEBIT CARD

Offline Demo



Touch here to pay by
CHECK

Processed by Sage (Certification/Test)



Cancel / Exit

Welcome To Howard Technology Solutions!

HOWARD™

Demo / Test

01:17

Insert Card to Process Payment

**** REMOVE ALL STICKERS FROM CARD BEFORE INSERTING ****

Payment Account
12345-001



Please swipe
your card as
indicated in the
image below.

Amount to Pay

\$.07

\$0.00 Fee Included

Processed by WorldPay

⊘ Cancel / Exit

⬅ Back

CASH PAYMENT INSTRUCTIONS

Welcome To Howard Technology Solutions!



01:53

Cash Payment



Insert cash below



**** Insert Bills One At A Time ****

Amount to Pay

\$1.00

Cash Inserted

0.00

⚠ Cash Payment Demo

⊘ Cancel / Exit

⬅ Back

Pay

CHECK PAYMENT INSTRUCTIONS

Welcome To Howard Technology Solutions!

HOWARD™

Software Development Payee Testing

01:21

Check Payment

Please Insert Your Check

Place a completed check into the scanner EXACTLY as shown.



Please insert your check as indicated in the image below.



Check Scanner Tray

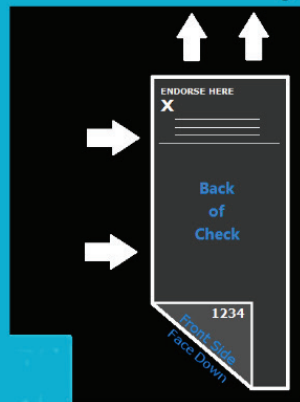

Amount to Pay

\$361.00

\$1.00 Fee Included

Processed by Sage (Certification/Test)

⊘ Cancel / Exit

⏪ Back

Scanning...

Welcome To Howard Technology Solutions!

HOWARD™

Software Development Payee Testing

Cash Payment



Please wait while your transaction is concluded

Transaction Total: \$2

Welcome To Howard Technology Solutions!

HOWARD™

Software Development Payee Testing

00:58

Thank you for your payment!

Your transaction is now complete

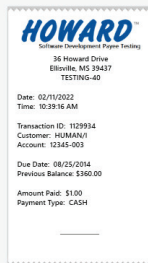

 **Print Receipt**

 **No Receipt**

 **Clear Screen**

LINE DRAWING & DIMENSIONS

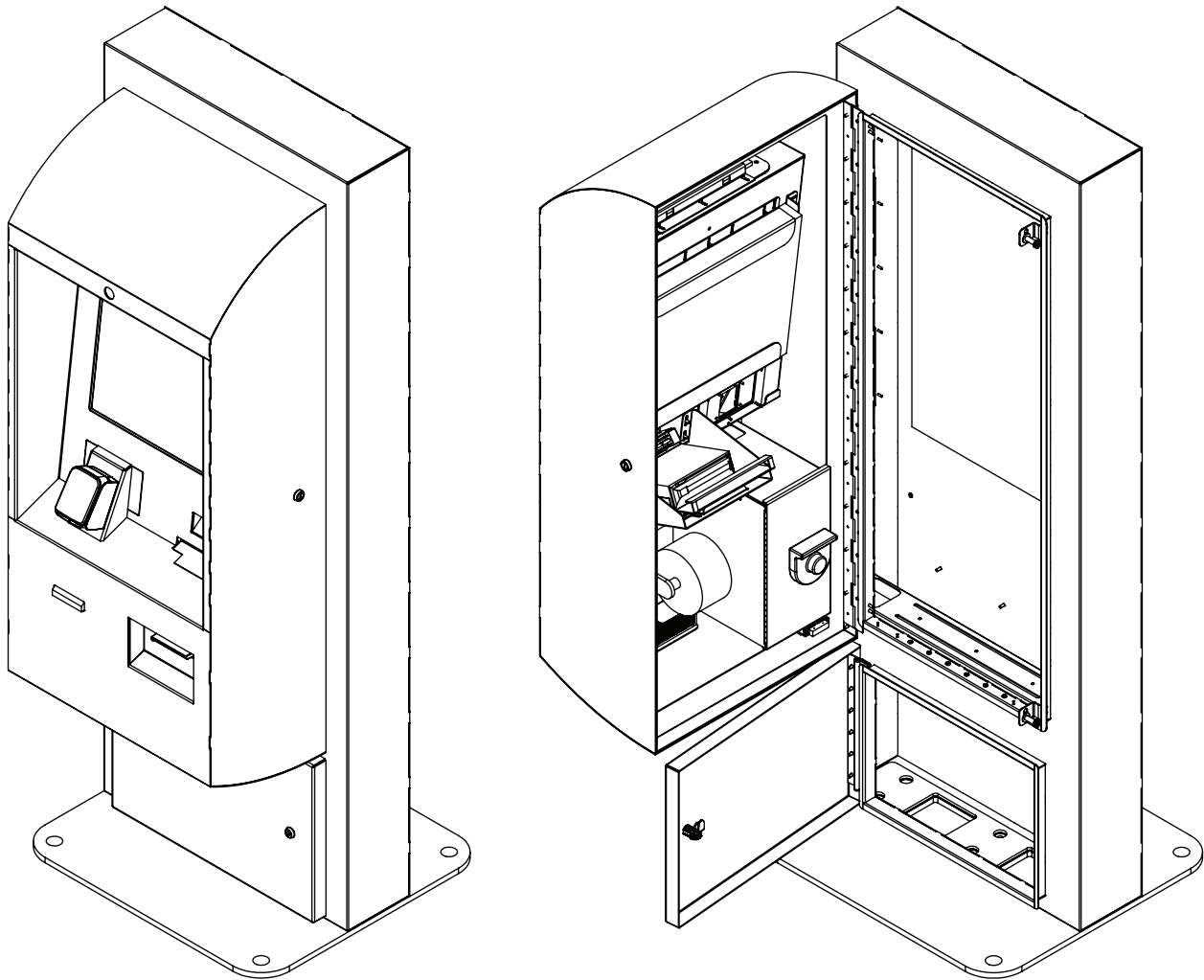

A/C Unit
 NOTE:
 Kiosk must be mounted so the A/C unit is no less than 4 inches away from an obstruction.

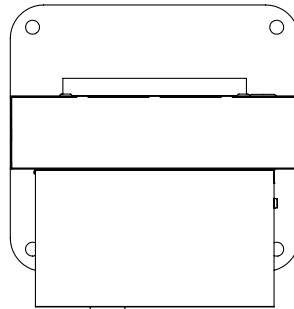

Top View

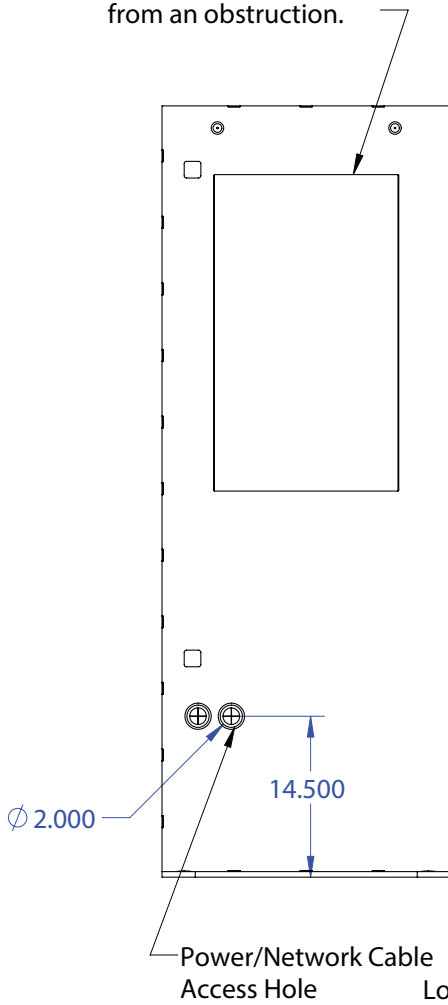

Back View

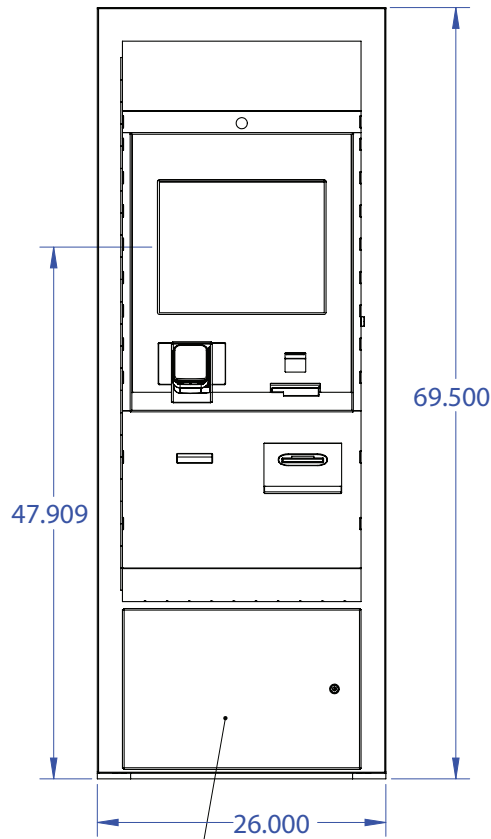

Front View

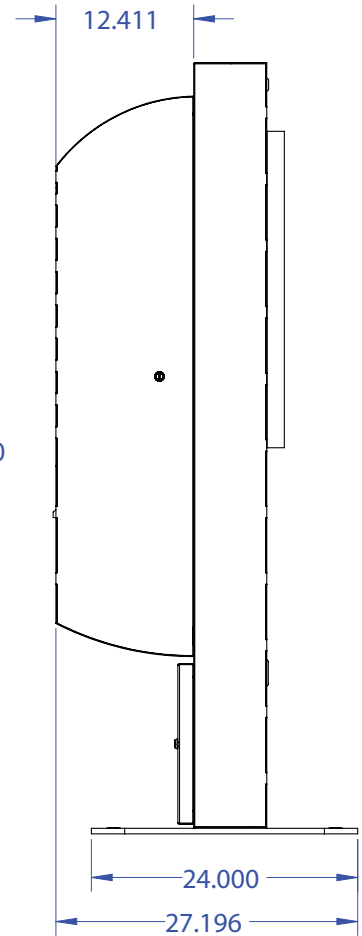

Side View

CONTACT INFORMATION

If you have any questions about our line of technology partner products, feel free to contact us for more information.

General Information

Toll Free: 1.888.912.3151

Customer Support

Toll Free: 1.888.323.3151

Technical Support

We provide FREE telephone technical support 24/7 (excluding US holidays) for as long as you own your Howard product. Our friendly, US-based team of experts will answer your questions about the product, hardware setup, or installation, and with telephone hold times of typically less than 1 minute!

For technical support call [888.323.3151](tel:888.323.3151)

