



HI-Paradigm



HI-Paradigm

The HI-Paradigm cart line provides the ultimate in medicine dispensing organization. The configurable drawers can be tailored to your distribution needs and help keep employees on track. The electronic locking keypad, coupled with our Med Manager software, provides our carts with premier security capabilities.



Ergonomic Features

- A short distance between the worksurface, keyboard tray, and patient bins reduces unnecessary arm movements and bending
- Ergonomic adjustable push handles with soft-touch grip on front of cart are available
- Rubberized foot rests on each side of the cart allow for a more relaxed stance and relieves fatigue
- Slide-out keyboard tray with integrated wrist rest (max keyboard dimensions 18.2" W x 7.5" D x 1.6" H)
- Keyboard is auto-leveling with a -15 degree negative-tilt and a positive-tilt up to 6 degrees
- Open architecture at wheel base allows end user to maintain their normal walking stride
- One-touch worksurface height adjustment allows for a full sit/stand range of motion (3 TIER ONLY SIT)
- 270° Vesa Mount to allow swivel full view when maneuvering cart
- Available with on-demand steer assist technology (SAT). When SAT is engaged, the rear casters act as pivot points, easing and stabilizing the navigation, and effortlessly allows the end user to navigate around corners, doorways, and other changes in direction



Other Features Include:

- Central control panel with convenient electronic worksurface and monitor height adjustment, lighting controls and storage management
- VESA monitor mount has tilt, swivel, and rotation adjustments
- Flexible storage configurations with add on capability can be customized to fit multiple workflows (narcotics locking options available)
- Universal accessory mounting locations on rear of cart and on monitor mount (choose from 12+ optional accessories)
- 270° wrap-around handle on sides and rear
- Large, raised-edge worksurface area (17"W x 14.3"D) with translucent protective cover
- Dedicated cable management area with easy access panels to manage and house excess cables
- Integral AC power distribution with 6 AC receptacles for powering customer equipment
- Large, fan cooled, PC compartment (17.1"W x 12.5"D x 3.2"H)
- Includes 7-port USB Hub
- Battery fuel gauge
- The easy-swap cassettes allow the HI-Paradigm cassettes to be easily swapped between the cart to a Transfer cart
- 8ft coiled power cord with hospital-grade AC plug with dual integrated hooks and integrated pull loop (Hospital Grade)
- (4) 5" dual wheel premium casters (2 locking casters on front)
- Tool-less battery cover (snap-on) and tool-less battery and power supply replacement
- Available with multiple power options that you can choose from to best fit your workflow, including Howard Powermax 150
- Remote cart monitoring and management software
- Advanced electronics are an option on the HI-Paradigm with features such as: drawer sensing, automatic drawer lighting, and drawer ajar alarm
- Mouse surface and mouse holder (left or right)
- Cart and cart accessories ship fully assembled in one box for convenience
- Advanced Electronics are standard on the HI-Paradigm carts with ajar alarm lighting and sensing
- Meets UL and CE standards



HI-PARADIGM E
3-TIER STORAGE

HI-PARADIGM E
6-TIER STORAGE



Cart Dimensions and Storage

The dimensions and data below is a comparison of the various HI-Paradigm carts. Contact your Howard Medical Representative for additional information.

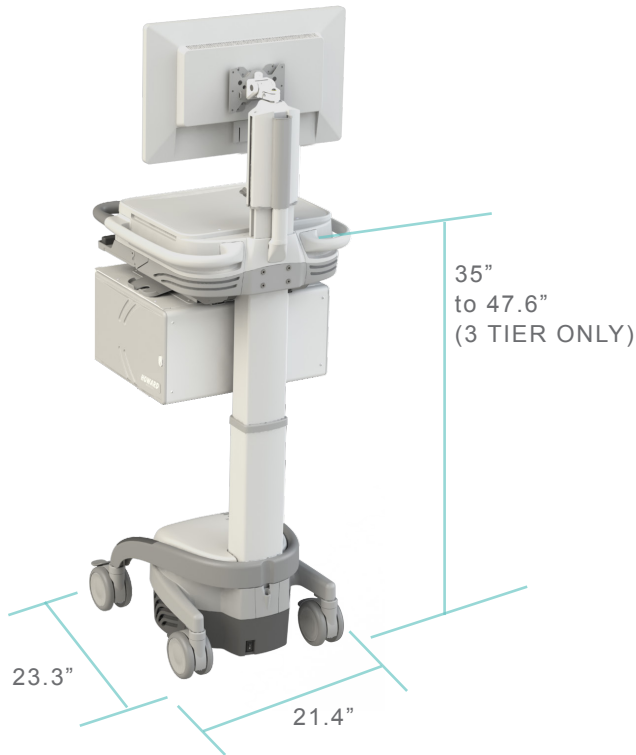

OVERALL DIMENSIONS

HI-Paradigm			
Storage		3-Tier	6-Tier
Overall Dimensions (in)	Width	21.4	21.4
	Depth	23.3	23.3
Work Surface Height Adj. (in)	Min	35.0	42.0
	Max	47.6	47.6
Base Footprint	Width	19.0	19.0
	Depth	20.0	20.0
Caster Size (in)		5.0	5.0
Writing Surface Size	Width (in)	17.0	17.0
	Depth (in)	14.3	14.3
	Area (ft ²)	1.7	1.7
Height Adj. Range (in)		12.6	5.6

PC Compartments		
PC Dimensions (in)	Width	17.1
	Depth	12.1
	Height	3.2

1-Tier Drawer

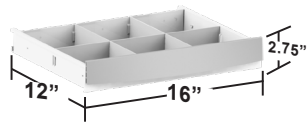

2-Tier Drawer

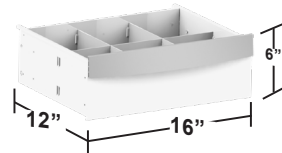

Howard's Advanced Medication Delivery System

Howard's unique, point-of-care, interchangeable cassette system is an easy-swap exchange method that allows medications to be cassette-transferred securely from pharmacy to patient bedside. Streamlining the medication dispensing process in this way increases accuracy and minimizes potential medication errors. (Howard systems adapt easily to centralized or decentralized models.)

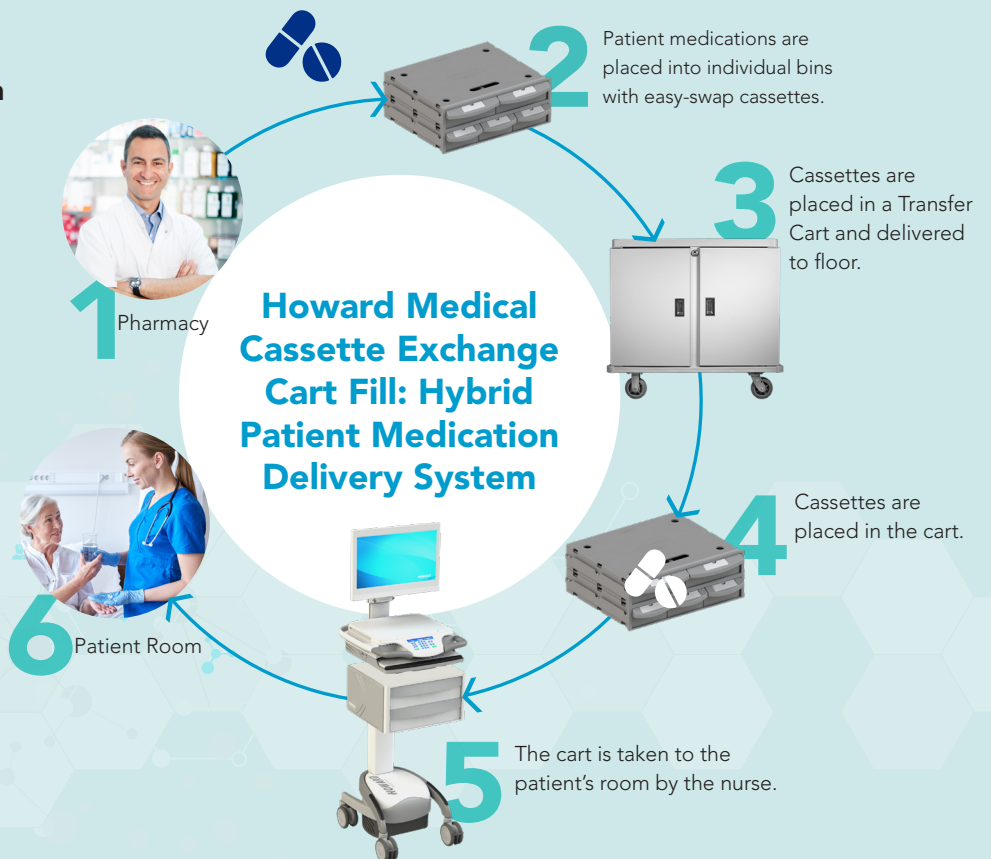

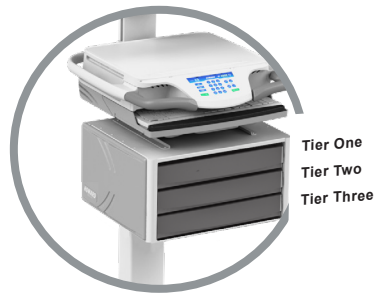

Storage Features:

- Med drawer lighting for continuous use in low light conditions without disturbing your patient
- Programmable secure access to storage drawers and patient bins via keypad on the cart's centralized control panel
- Independent bypass key for manual emergency access
- Automatic relock with adjustable timer (6 seconds - 1 hour)
- Audible beep for code entry confirmation
- Supports up to 2000 unique user IDs (3-8 digits)
- On Screen drawer configuration and status via Med Display
- Local management of user IDs and locking system settings via Med Display
- Remote management of user IDs and locking system settings via Med Manager
- User ID, time, and date of each unlock event is stored in an audit log
- Locking system status displayed by LED's on the cart's centralized control panel
- Powered by cart power system
- Optional independent narcotics security
- Configurable secure storage options
- Patient bins are in quick swap cassettes
- Dividers included with all drawers and patient bins
- Magnetic sensors detect which drawers and patient bins have been opened
- Drawer open alarm notifies user when a drawer is left open

HI-Paradigm Narcotics Locking Option

- Narcotics locking option available for the six-tier configuration
- Provides second-level locking for the uppermost drawer
- Bypass key included for emergency access
- Narc drawer can be a 1 or 2-tier tall drawer
- The narc drawer option is not compatible with 3-tier storage cabinet

Features	Basic Electronics	Standard Paradigm/Pinnacle
Storage		
Auto-light power-on when unlocked, auto power-off when Relocked.	✓	—
Auto light power-on when any drawer is opened, and auto power-off when <i>all</i> drawers are closed.	—	✓
Programmable lower limit lift column allows easier in field storage cabinet expansion options.	✓	✓
Drawers and Bins		
Audible alarm on open bins	—	✓
Both audible and visual (flashing red task light)	—	✓
Audit Trail (allows tracking of following information)		
Name, User ID, time of unlock, time of relock, and drawers accessed	—	✓
Drawers left open at relock	—	✓
User Support		
2,000 user Support	✓	✓
Add up to 3 users from keypad outside of Medical Manager Software	✓	✓



Accessories Options

Howard offers several accessory mounting options and configurations that provide a smoother and more sanitary work flow. With hundreds of options and configurations available, you can tailor your cart to best fit your facility's needs and applications.

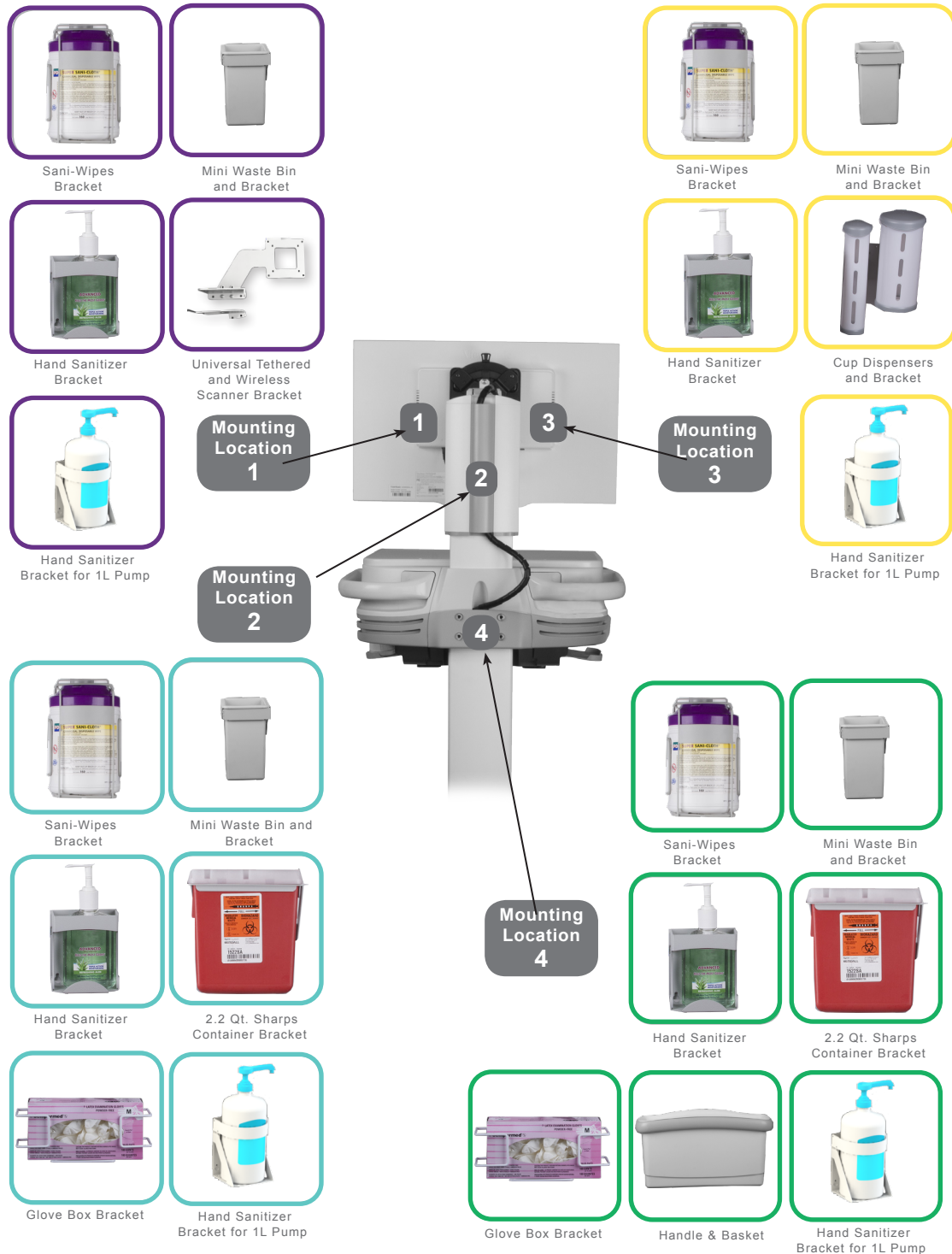

accessory options may vary between carts
mounting locations are not available for all Howard carts



Warranty

Howard Medical's commitment to providing unmatched customer service and support continues long after a sale is final. Our technology staff provides 24/7 technical support (excluding US holidays) for as long as you own your Howard product. Our friendly, US-based team of experts will answer your questions about the product, hardware setup, or installation, and with telephone hold times of typically less than a minute.

Standard Limited Warranty on Powered Medical Carts:

- 3-year mechanical
- 3-year electrical
- 3-year lithium phosphate battery defect
- 3-year lithium phosphate battery performance

Upgraded Limited Warranty on Powered Medical Carts:

- 5-year mechanical
- 5-year electrical
- 5-year lithium phosphate battery defect
- 5-year lithium phosphate battery performance

Computers and Other Peripheral Devices:

- See manufacturer's warranty

For our full warranty information, please visit <https://www.howardcomputers.com/support/warranties.cfm> or contact your Howard Representative.

Professional Services

The Howard Medical Professional Services Team has technical specialists nationwide and is known as one of the industry's premier service providers, with a history of successfully serving clients for more than a decade. Our dedicated employees are completely focused on customer satisfaction, giving Howard Medical the resources to provide a solution that is just right for you. Whether your project is large or small, single-site or across multiple facilities, you can trust our experience to work for you!



Deployment Consultation



In-Service Training



Technical Integration & Setup
Training / Consultation

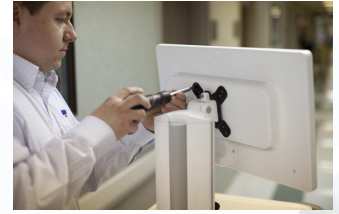

Preventative Maintenance

- Annual Fleet Audit
- Care Protection Services Solutions
- Complete In-Factory Integration
- Equipment Cleaning With Disinfectants
- Equipment Disposal
- In-Factory Imaging
- In-Service Training

- On-Site Repair
- On-Site Troubleshooting
- Preventative Maintenance
- Technical Training
- Technical Installation
- Technical Integration & Setup Training/Consultation
- White-Glove Delivery With Trash Removal

Care Protection Service Solutions



Silver Service
Level Agreement



Gold Service
Level Agreement



Platinum Service
Level Agreement

Howard's Care Protection Service Solutions give any facility the ability to choose the level of service that works best for them. For our full services information, please visit https://www.howardcomputers.com/Support/pro_services.cfm

Howard Medical Point of Care Carts

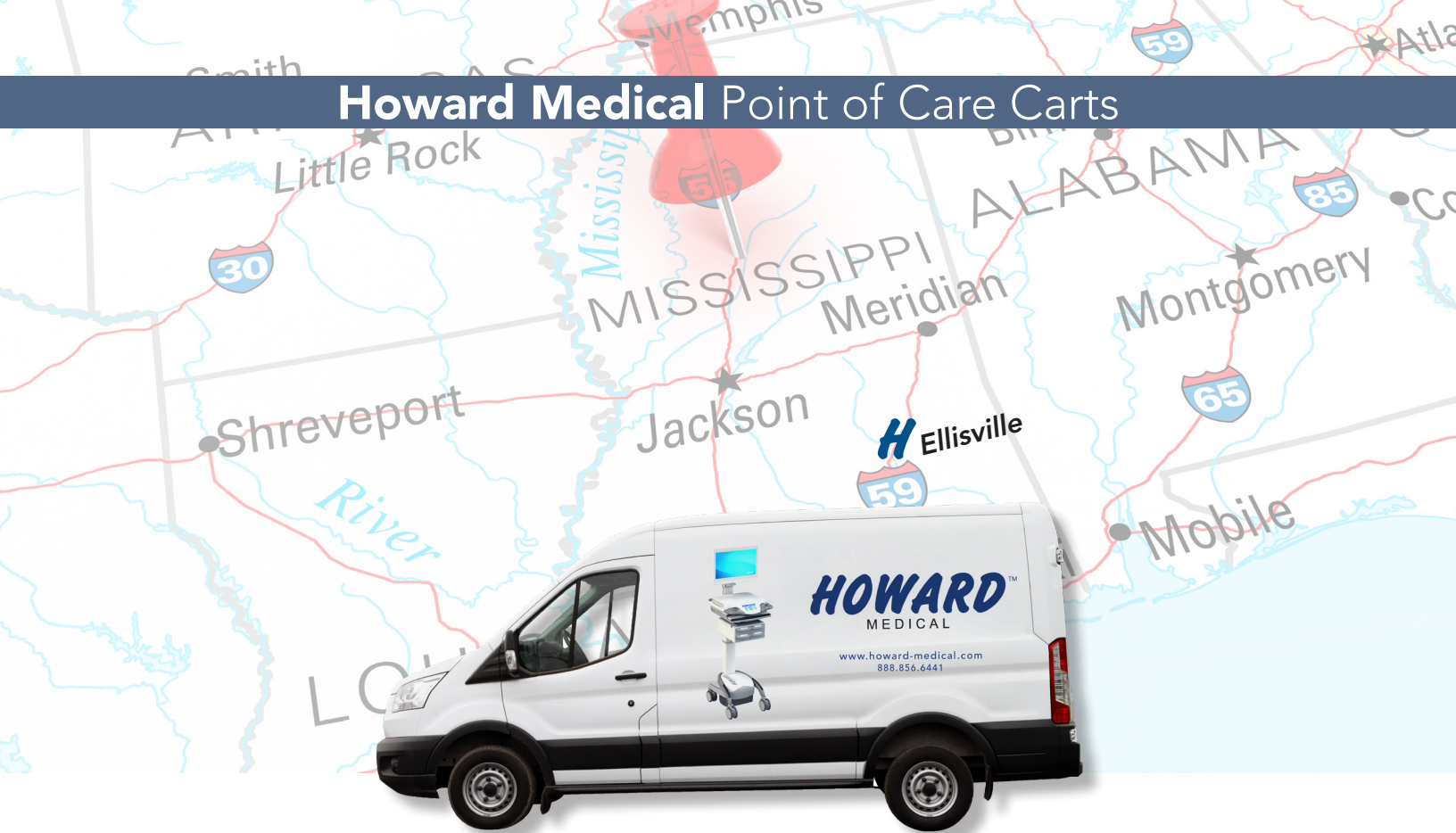

Designed and built in Ellisville, Mississippi for over 20 years. Backed by our nationwide network of Howard Certified Technicians as well as 24/7 phone based support.

SALES REPRESENTATIVE:

TERRITORY/REGION:

EMAIL:

PHONE:

Web:
www.howard.com

Customer & Technical Support:
Toll Free: 1.888.323.3151
24/7 (excluding US holidays)

General Information:
Toll Free: 1.888.912.3151

